

THE COMPLETE RAINSCREEN SOLUTION FOR LIGHT COMMERCIAL AND RESIDENTIAL PROJECTS

Building professionals of residential and light commercial properties can experience the benefits of MEG's durable exterior cladding system with the new MEG 1500 program. Designed specifically for building professionals with light commercial and residential projects, modular builds, or those looking for ways to economize, the MEG 1500 system comes

complete with pre-fabricated 8mm panels, screws and attachment profiles. We stock our most popular exterior colors in a variety of prefabricated panel sizes to deliver a complete rainscreen cladding system in approximately 4-6 weeks, which is ideal for projects requiring fast turnaround and quick material delivery.

Getting started is easy!

1. CHOOSE FROM OUR MOST POPULAR COLOR OFFERINGS



604
Wood



758
Wood



754
Wood



756
Wood



770
Wood



713
Metallic

* Colors from the complete MEG exterior color collection not shown above can be special ordered, but are subject to longer delivery timeframes.

2. SELECT FROM A VARIETY OF PANEL SIZES

Arrows indicate panel direction. Keep in mind that panels have a top and bottom and will be marked accordingly. Inverting panels could result in shading differences from panel to panel. Arrows also indicate the grain direction for panels with wood grain finish. All standard colors are woodgrain except for 713.

Size 1

101 1/2" W x 50 1/2" H

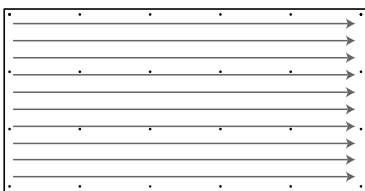

Size 2

50" W x 50" H

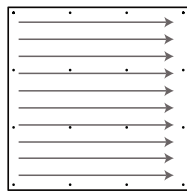

Size 3

101 1/2" W x 25" H

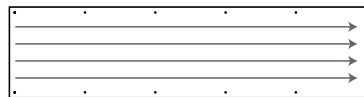

Size 4

101 1/2" W x 12 1/2" H

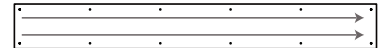

Size 7a

12 1/2" W x 50 1/2" H



Size 7b

50" W x 12 1/2" H

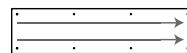

Size 8a

25 1/2" W x 50 1/2" H

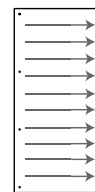

Size 8b

50" W x 25 1/2" H

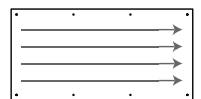

Size 5

101 1/2" W x 6" H

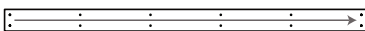

Size 6

25 1/2" W x 25 1/2" H



Different sized panels can be used interchangeably to create unique facades.

However, screw holes may not form linear patterns on the finished facade when various sized panels are used in combination.

* Please note that all panels are 8mm in thickness. Be sure to review the building code requirements of your project prior to ordering.

3. SELECT ACCESSORIES

Your MEG 1500 rainscreen system comes complete with hanging profiles and 10 x 1" color-matched screws. Simply select the profile type and quantity based on the desired panel layout for your build project. Vent screens are available for an additional fee.

J Profile

Black Anodized Aluminum 10 ft.

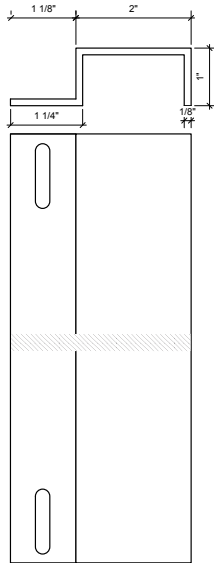

HAT Profile

Black Anodized Aluminum 10 ft.

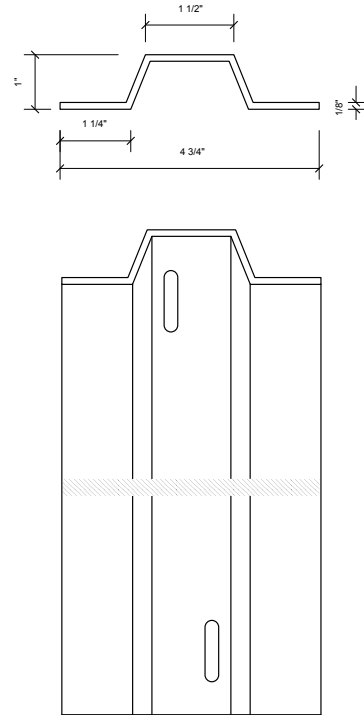

4. CHOOSE A SHIPPING METHOD

Your MEG 1500 system will ship within 4-6 weeks from order placement. Your order can be shipped via van trailer or flatbed service, whichever you prefer. The large size, shape and weight of MEG 1500 panels may require that you be equipped with a forklift and/or the manpower needed to off-load the panels upon delivery. If you feel that you are not set up to off-load the panels from a van trailer, we suggest you consider using a flatbed service. Flatbeds offer various access points, making it easier to off-load MEG 1500 panels.

Go to www.MegWallPanels.com/MEG1500 to order your MEG 1500 system today!

* MEG 1500 is for building professionals looking for a pre-packaged solution for their building facade projects. MEG 1500 does not include material take-off services, shop drawings, panel layout services or any engineering services.